

Sensitivity: LB : 5 mikrovolts
 MBI : 5 "
 MBI : 8 "
 KB : 10-60 "

Output : max 10% dist. at 800c/s on trans sek. 4 Watts

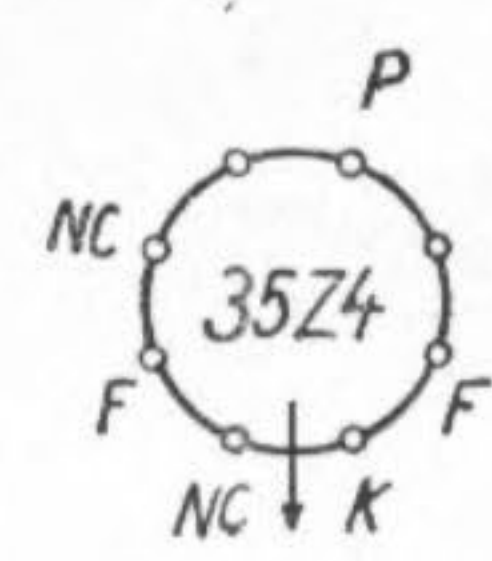
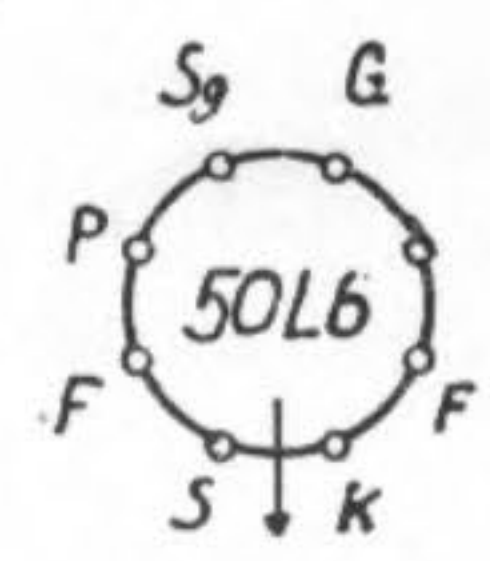
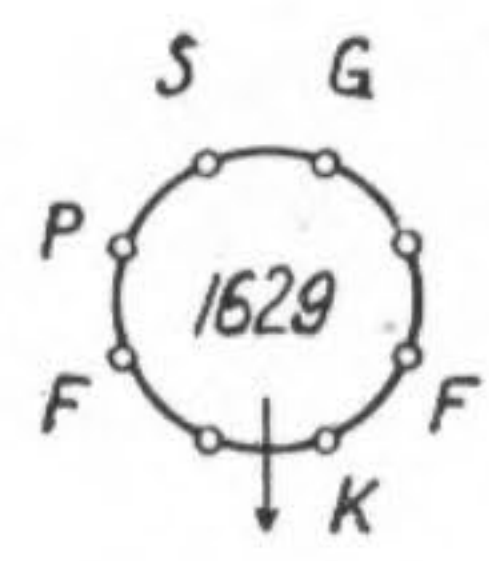
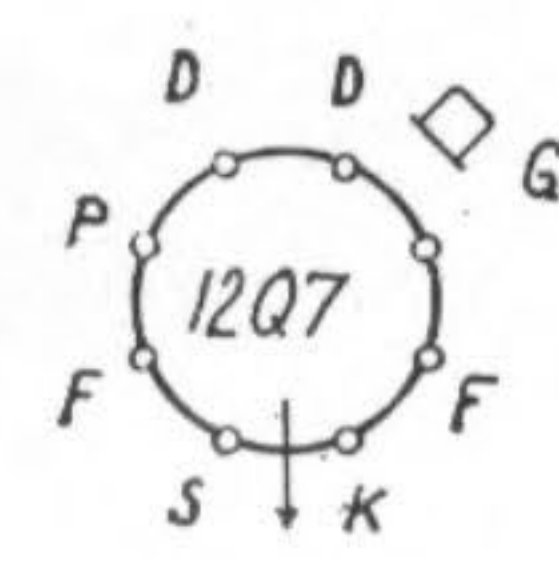
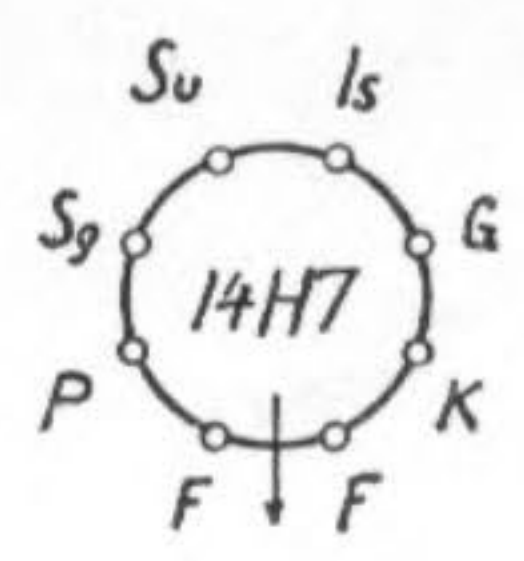
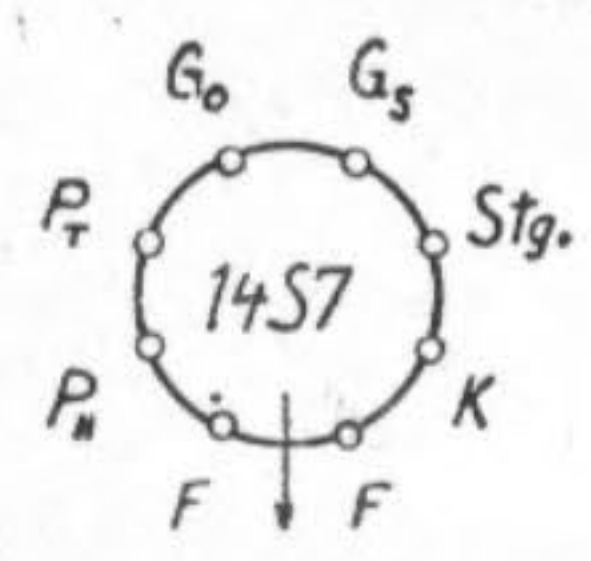
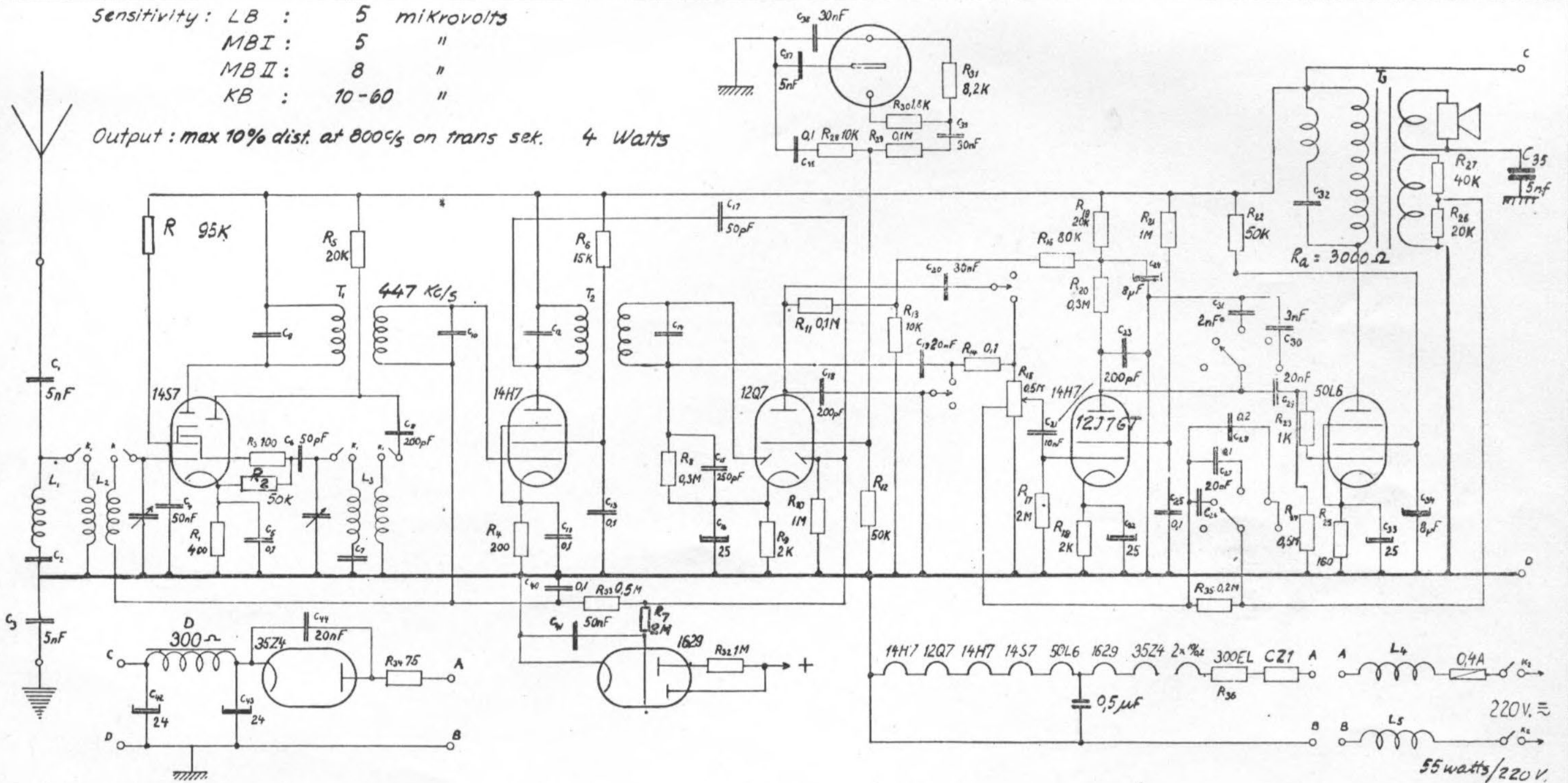

660UG
 Hede Niensens Fabrikker A/S
 Horsens