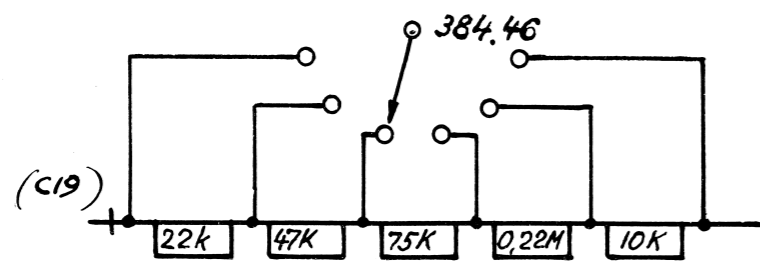
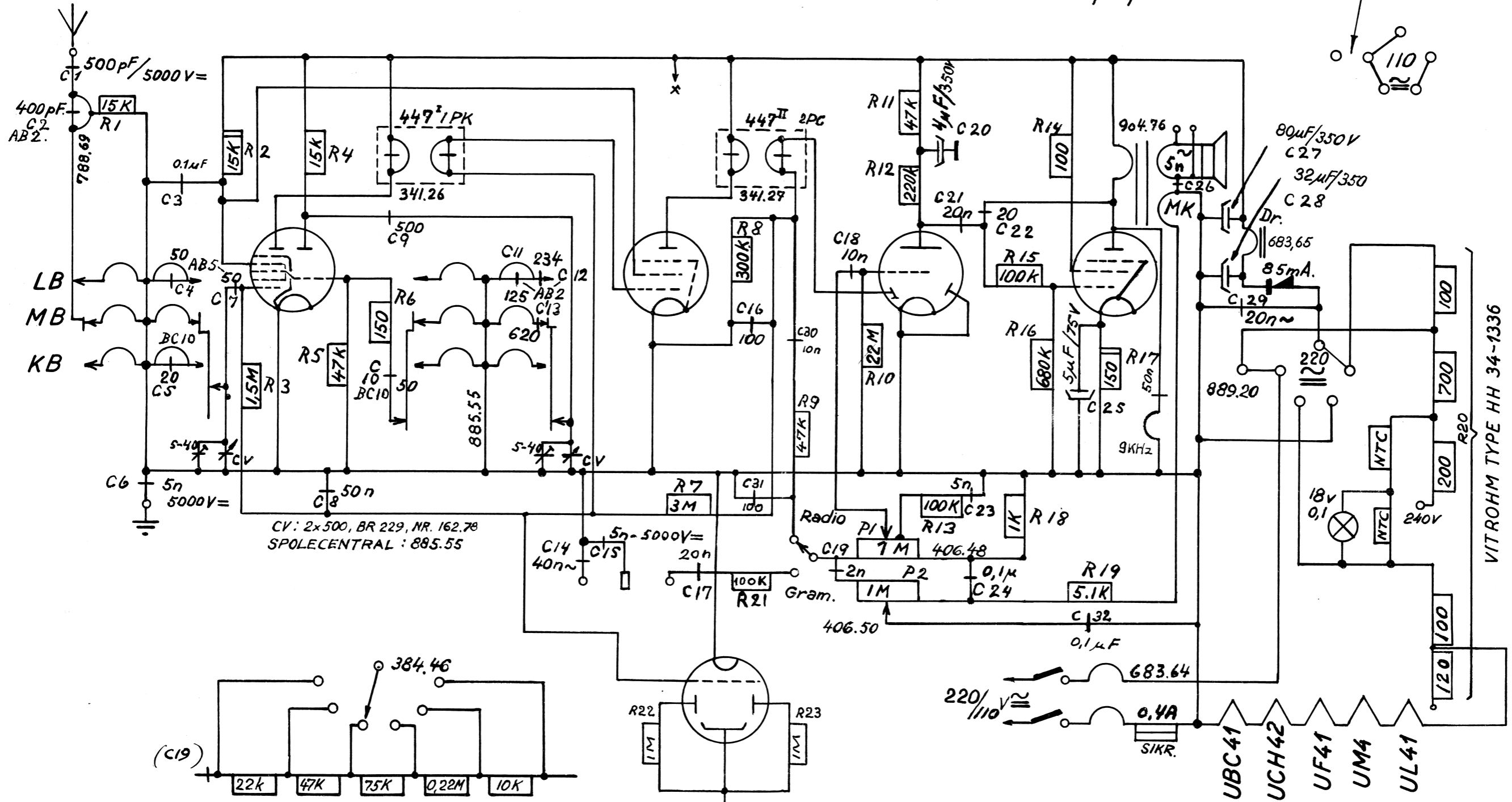
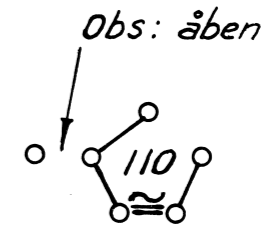
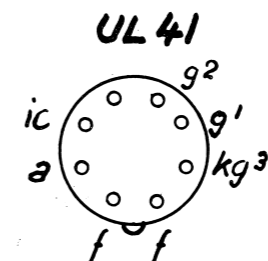
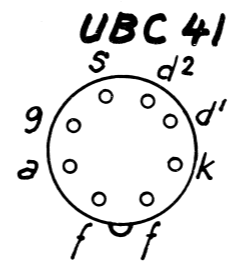
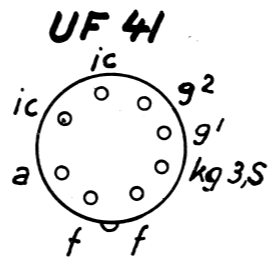
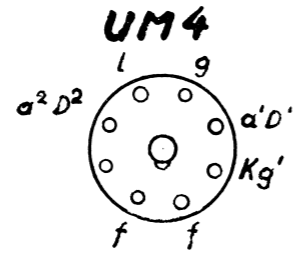
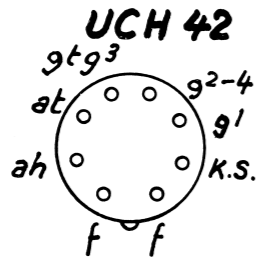

*Diagram over*

**TOR VENUS F2** AM <sup>110</sup>/<sub>220V</sub>~

**TOR**



INDGÅR SOM TRINVIS VARIABEL KLANG-  
 FARVEREGLERING NÅR P2 UDGÅR

**TOR VENUS F2** AM <sup>110</sup>/220V<sub>≈</sub>